

72 hrs  
18 - 29°C

1. Acclimation Requirements - 72 hrs between 18 - 29°C. Check your Arden Flooring Herringbone for any damages to the plank or jointing lips. Dispose of damaged planks. Read Instruction manual supplied in the box for preparation and in depth advise.

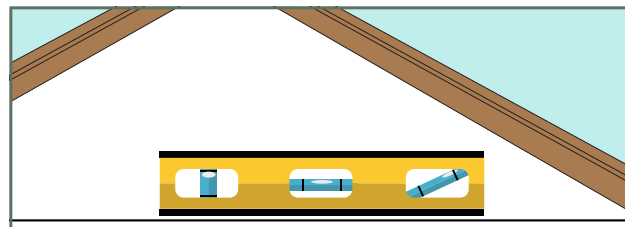

Max 3mm within 2mtrs

2. Subfloor Flatness Tolerances - Max 3mm within 2m (BS 8203 - SR1). Vacuum the floor to ensure the surface is free from debris. Can be used with In-floor Radiant underfloor heating. Source must be min 13mm below flooring. Max Operating floor temperature 29°C refer to instruction manual. Remove any skirting or trims prior to installation.

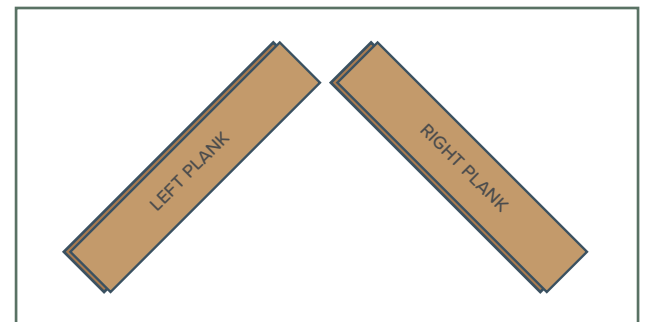

LEFT PLANK  
RIGHT PLANK

3. Note that there are two differently milled click Herringbone planks in each box, 12 RIGHT and 12 LEFT; you can easily identify them with their different profiles as shown above. When opening boxes, set out planks in separate piles of LEFT and RIGHT planks to make installation more convenient.

**FIGURE 1**

**NOTE:** The first guideline you set up should be positioned 45mm to the right of the centreline as shown below.

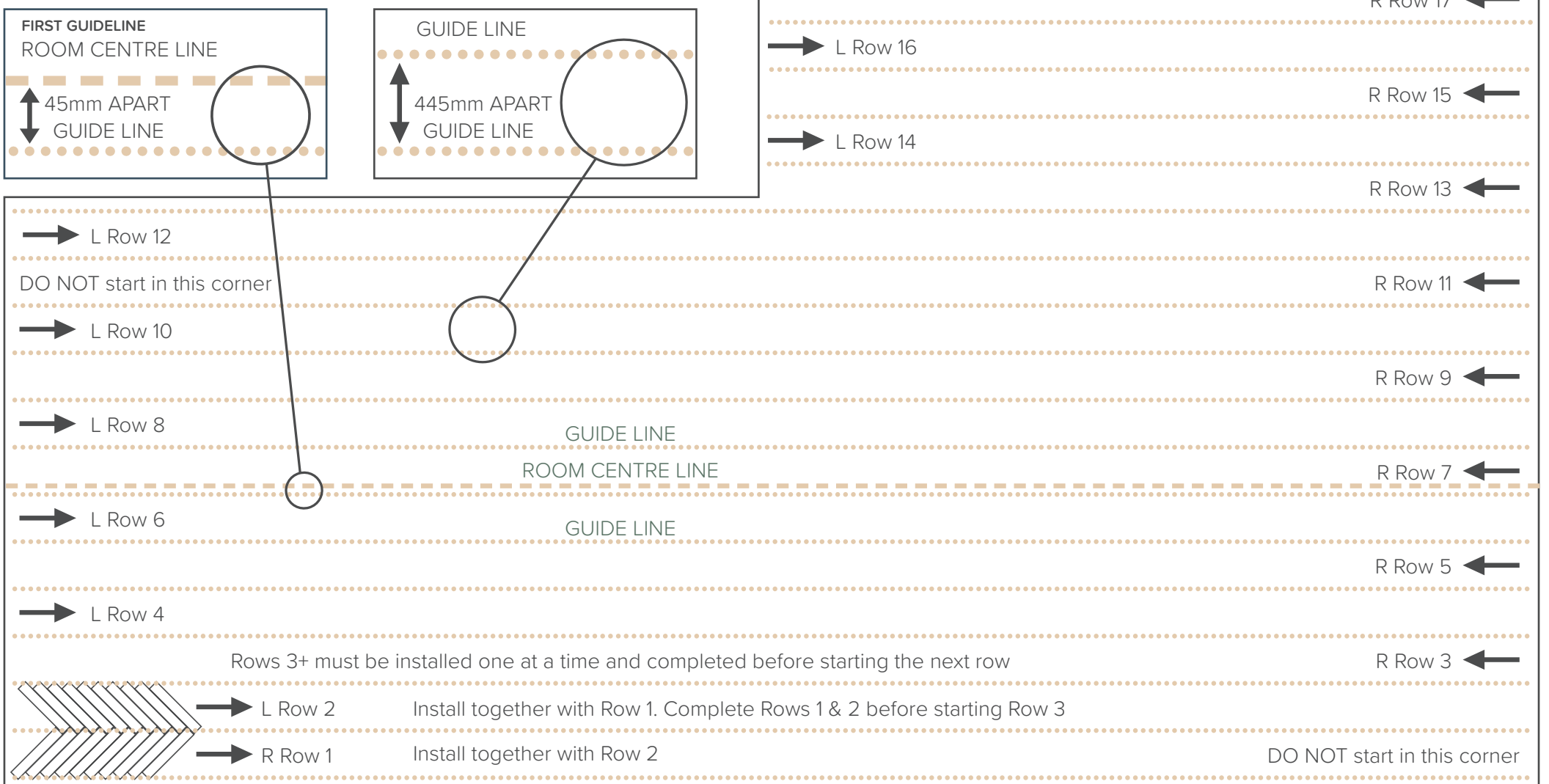

4. Your initial set-up and planning of the room is key to a successful installation. For the optimal appearance of the floor, herringbone floors should be centred along the length of the main body of the room so that the cut pieces on both sides are the same size and the floor symmetrical. First measure and mark your installation area's centre line using your chalkline. Next, to mark out the guidelines, off-set the first guideline by 45mm from the main centre line, the continue add the rest of the guidelines 445mm apart from each other. NOTE: You can only start your floor installation in either of the 2 opposing corners shown above. The alternative starting corner is noted in the opposite corner with a \*, however this is not recommended since this is the smaller area of the installation. Ensure the planks are fitted in the correct sequence, DO NOT start installing in a different corner or any position or row in the room.

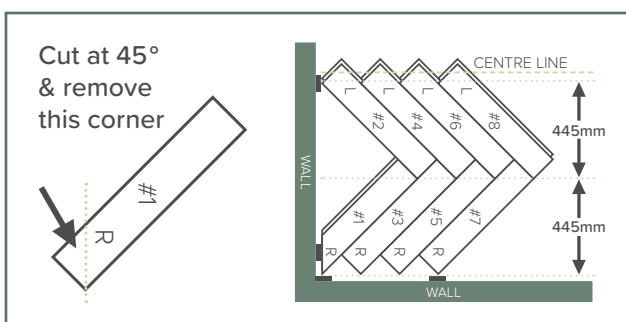

Cut at 45° & remove this corner

5. Your initial set-up and planning of the room is key to a successful installation. For the optimal appearance of the floor, herringbone floors should be centred along the length of the main body of the room so that the cut pieces on both sides are the same size and the floor symmetrical. First measure and mark your installation area's centre line using your chalkline. Next, measure out from the centre line and mark out each of your guide rows using your chalkline, off-setting by 445mm from the centre line.

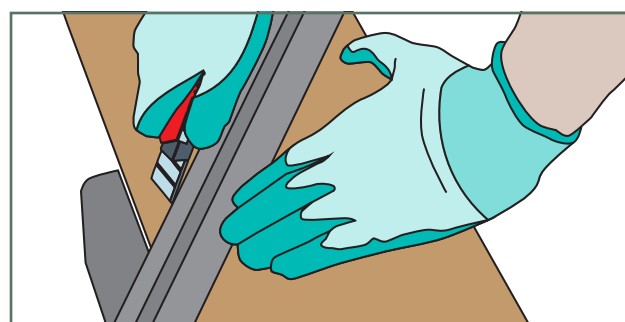

6. To cut your Arden Flooring Herringbone planks to size, measure and mark with a pencil. Using a combination square and utility knife, apply pressure and score along the line. Gently flex along the scored edge until it separates into two pieces.

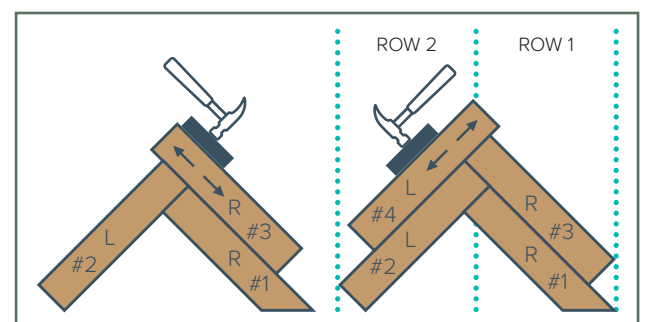

ROW 2  
ROW 1

7. Starting your first row is simple (double row); position and lock right and left planks together in the sequence shown above. This will form a double row (row #1 will use RIGHT planks only and row #2 will use LEFT planks only) in the form of an "inverted V". Position and lock each plank in place exactly following the numbered sequence shown. The joints are connected by inserting the adjoining plank at 15-20° then sliding them to fully align with previous plank before lowering the plank and locking it into position. A tapping block and rubber mallet can be used to close any small gaps and ensure full alignment.

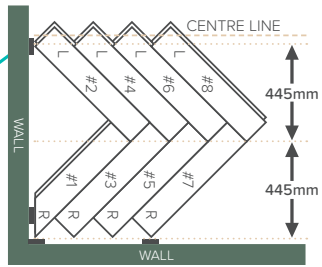
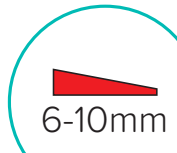

8. Left & Right planks are grouped together in the box. For ease of installation, keep these separated. Begin installing click Herringbone from one corner of your room and always work to the right. Use spacer wedges next to any piece that meets a wall to ensure a 6-10mm expansion gap is left around the perimeter. You must begin installation from starting points shown in Figure 1 Diagram ensuring the tiles are fitted in the correct sequence.

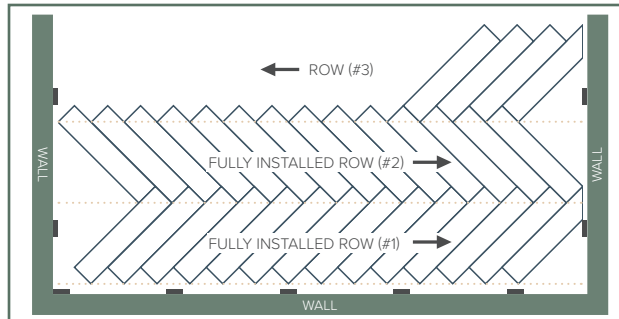

9. You must fully install your starting double rows (#1 & #2) before moving on to more rows. This should be perfectly straight and free of any gaps. You are now ready to start row #3 which will only use RIGHT format planks. Make sure that you insert row 3 starting from the right side of the room working to the left as shown. Continue inserting "single rows" using the correct handed plank and installing them in the correct direction as Figure 1. Failure to do this will result in the locking joints being damaged and the floor failing.

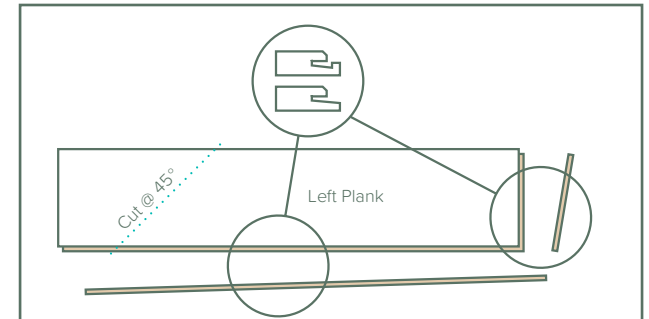

10. When fixing the infill cut planks to complete the floor, it may be necessary to slice off the upper lips of the female joints so that they slide under the fitted planks. Use a utility knife to slice off the upper lip of the joint on the end of the plank. Apply multiple beads of seam sealer to both sections of the profile to secure the cut plank in place.

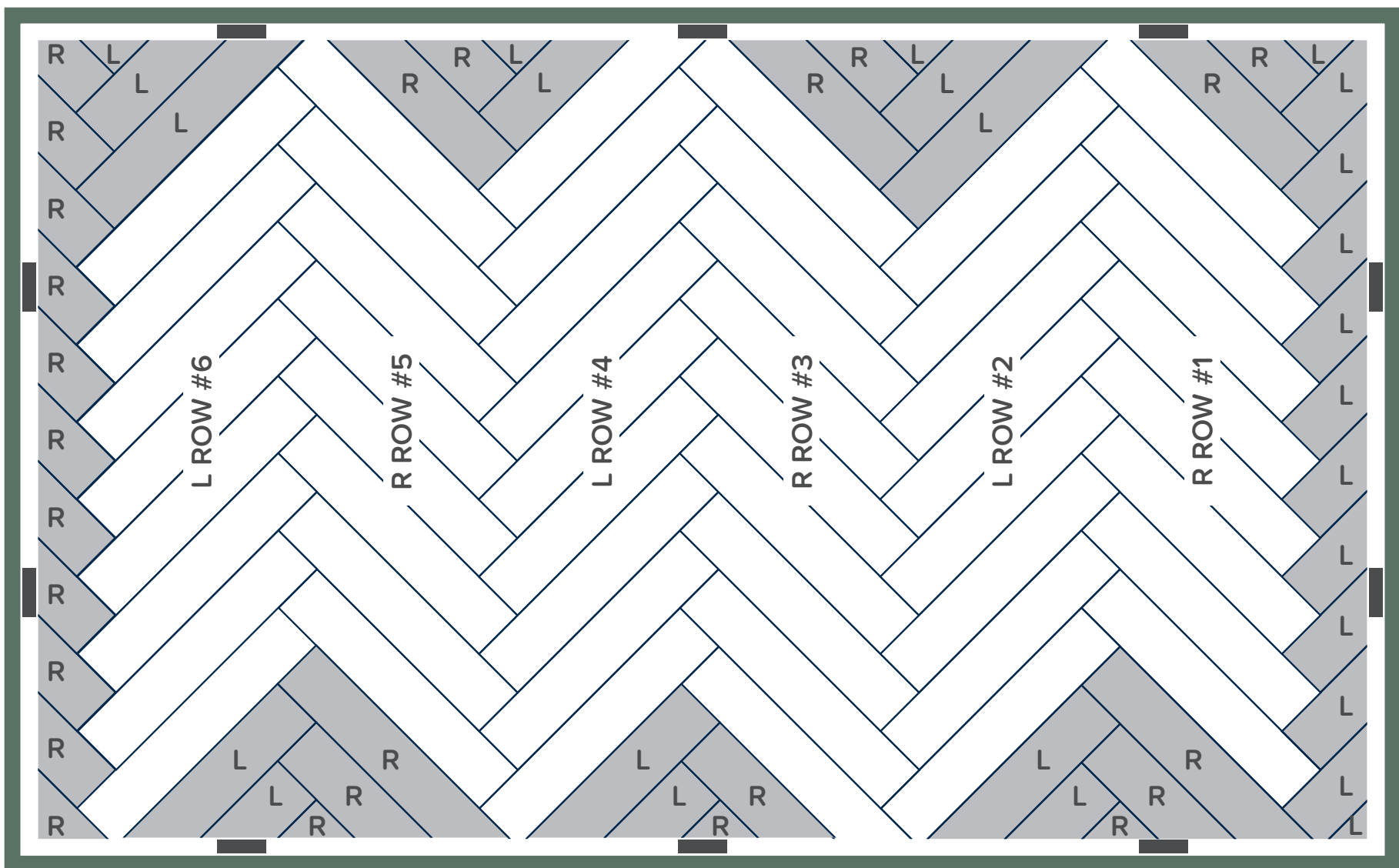

11. Now that you have all of the main body of the floor installed, you are ready to start to install your cut rows and fill in your "triangle" shaped openings at each end of the room. Mark your cut-line on the plank at 45° so that when installed, you maintain the required 6-10mm expansion gap. Before inserting the cut planks, apply multiple beads of vinyl seam sealer to both of the female profiles of the existing planks in the floor where the cut plank will fit. Immediately and thoroughly wipe up any excess seam sealer that may bleed through from the seams using a clean paper towel. The upper female lip joints may require removing on infill tiles to allow them to be inserted underneath the fixed tiles (See Step 10).

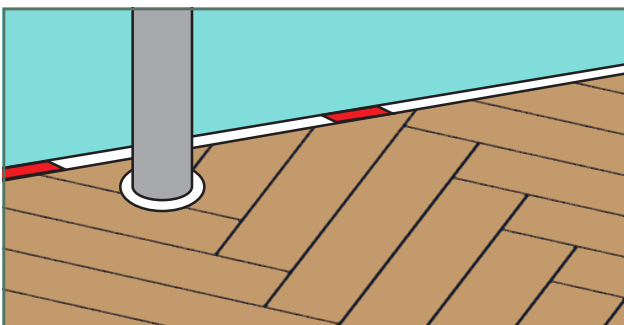

12. Click Herringbone can be easily fit around pipes by using a hole saw. Ensure you leave a 6-10mm expansion gap. Using a utility knife cut from the edge of the hole to the edges of the plank allowing the pieces to be inserted around the pipe. Reattach the pieces together using PVA glue and wipe away any excess glue with a damp cloth. Always leave a 6-10mm expansion gap around all pipes and objects.

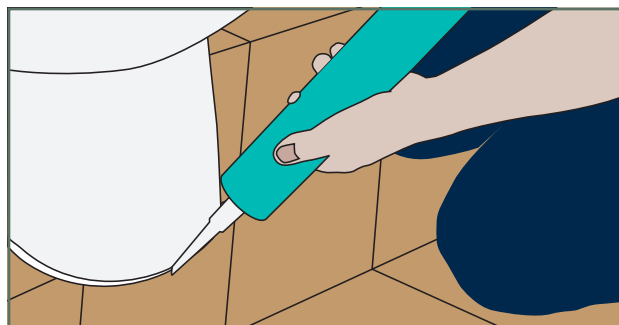

13. For splash areas such as bathrooms, waterproof skirting/scotia/trims can be used. Cut the flooring around your WC base leaving a 6-10mm expansion joint. 100% Silicone sealant can be used to fill in the gap. Silicone can be used in small areas such as around sink pedestals but should not be used on large areas as it will restrict the expansion and contraction of the flooring causing the joint edges to fail.

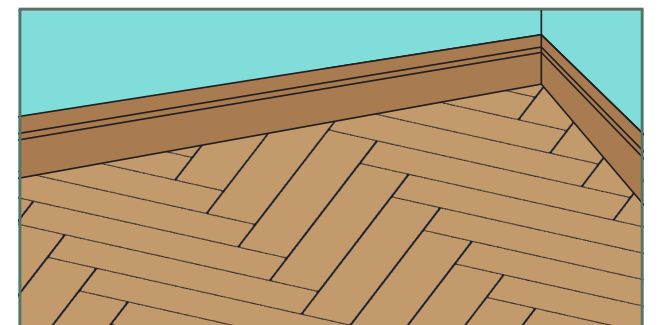

14. Continue to work left to right row by row. Once the floor is complete, remove the spacer wedges. Finish the look with skirting boards around the perimeter to conceal the expansion gaps. The skirting must be fixed to the walls and not the floors. Cut your flooring around heavy objects, furniture and pipework leaving a 6-10mm expansion joint. All door thresholds must also have 6-10mm expansion joints incorporated to enable the flooring to expand and contract. Protect SPC Flooring from exposure to direct sunlight via the use of window-treatments or UV-tinting on windows.

# SPC | Herringbone

## Installation Instructions

### Important information

- All instructions and recommendations must be followed to ensure successful installation and to keep the warranty valid.
- Boxes must NOT be stored or transported on their narrow sides as this will damage the connecting edges. Boxes should be stored on a dry, flat, level surface.
- You must acclimatize SPC Herringbone flooring for 3 days horizontally on a smooth flat surface at room temperature between 18°C and 29°C prior to installation. Leave the products in their original packaging until time of installation. If it is not possible to keep your SPC herringbone flooring floor on site, it must be stored indoors horizontally on a smooth flat surface, in a warm, dry place between 18°C and 29°C, away from direct sunlight and changing temperatures.
- Always ensure that the installation area is clear of dust and debris before beginning installation.
- Always inspect the product for defects and damages BEFORE installation.
- To achieve a natural look, open multiple packs and mix up the planks.
- Careful and correct preparation of the sub-floor is important to ensure successful installation.
- SPC herringbone flooring should be fitted as a “floating floor”. This means that the planks should be loose laid over the sub-floor and should not be glued down with adhesive.
- If you are installing over an existing floor, the existing floors must be securely attached to the sub-floor and be smooth, flat, stable free from dirt and debris, eliminating any heavy roughness or unevenness.
- Never install SPC herringbone flooring products over residual asphalt-type (cut back) adhesive. Residual cut back adhesive should be completely removed and covered with high quality latex screed.
- SPC herringbone flooring does not require an underlay as this is already built into each plank. Use of additional underlay will void the warranty and hinder successful installation.
- NOTE: Avoid installation over sub-floors with excessive flex or deflection. The installation of SPC flooring will not reduce any flex or deflections in the sub-floor. Excessive sub-floor deflection may damage the locking system and cause it to fail

### Owner/Purchaser/ Installer Responsibilities

- It is the sole responsibility of the Owner/Purchaser/Installer, prior to installation, to verify that the area/environment planned for installation is suitable for SPC Herringbone flooring and meets all local building codes and that all sub-floor is dry, sound, flat and clean and meets or exceeds all industry standards; as well as the recommendations listed herein. The manufacturer and distributor accept no responsibility for product failure extending from or related to failure to meet job area/environment and sub-floor requirements.
- The Owner/Purchaser/Installer assumes full responsibility for the final inspection of this product. Inspection should be done prior to installation and should include: colour, factory finish, milling and/or locking system damages. If the product is not acceptable, DO NOT install it. Contact your supplier immediately for assistance. This SPC Herringbone flooring warranty DOES NOT cover materials with visible defects after they are installed.
- This product may be installed over a radiant heating system, the system must be an embedded type (circulating or electric) and be a minimum of 12mm (1/2”) below the sub-floor installation surface and never in direct contact with the SPC Herringbone floor. Temperature must never exceed 29° C and changes in temperature settings must be gradual. It is the responsibility of Owner/Purchaser/ Installer to confirm the suitability of the radiant heating system for use with this product. The selection and use of any radiant heating system is the choice and sole responsibility of the Owner/Purchaser/Installer.
- Certain condominium and other multi-unit type building associations and/or owners may have floor covering acoustic performance requirements that may exceed the acoustic performance levels of this product, thereby requiring that a supplemental acoustical underlay is required. When installing this product in condominiums or other multi-unit type buildings, it is the sole responsibility of the Owner/Purchaser/Installer to ascertain if this product meets their acoustic performance requirements prior to its installation.

### IMPORTANT HEALTH WARNING to installers when removing EXISTING resilient flooring

If you wish to remove previously installed resilient flooring, please note the following: Your existing resilient flooring, backing, lining felt, asphalt cut-back adhesives or other adhesives MAY contain asbestos fibres and/or crystalline silica. DO NOT grind, chip, sand, drill, saw, bead-blast or pulverize this material in any way; either by hand or by machine. Avoid creating dust when working in contact with these materials. The inhalation of dust from these materials is a known cancer and respiratory tract hazard. The wearing of an approved dust mask suitable for this type of dust is recommended. Unless you are absolutely certain that the resilient flooring you are removing is a non-asbestos material, you must assume that it contains asbestos. Local regulations may require that the material be tested by an approved laboratory or agency for asbestos content and, if confirmed, regulated removal / disposal of the material may be required. For more information, please refer to the current edition of the Resilient Floor Covering Institute (RFCI) publication: “Recommended Work Practices for Removal of Resilient Floor Coverings” ([www.rfci.com](http://www.rfci.com)).

### Installation tool and accessory requirements

Before starting to install your SPC herringbone flooring floor, ensure you have all the necessary and correct tools, equipment and accessories, including:

- LVT flooring pull bar
- Rubber mallet
- Pencil
- Chalk-line & chalk (string-line)
- Dust pan & brush
- Tape measure
- Safety glasses/goggles
- Saw (mitre, chop, hand, circular or jigsaw)
- Hammer
- Straight edge or ruler
- Tapping block
- 10mm (3/8”) spacers
- Utility knife & sharp blades

**Before you start the installation of your SPC Herringbone flooring you must do the following:**

- When calculating flooring square metre requirements, allow between 10% to 20% waste depending on the size of the area being installed for waste, cuts, future needs and replacements. Smaller areas will have a larger waste factor.
- You must acclimatize SPC Herringbone flooring for 3 days horizontally on a smooth flat surface at room temperature between 18°C and 29°C prior to installation. Leave the products in their original packaging until time of installation. If it is not possible to keep your SPC Herringbone flooring on site, it must be stored indoors horizontally on a smooth flat surface, in a warm, dry place between 18°C and 29°C, away from direct sunlight and changing temperatures.

**Preparation of your sub-floor**

- Floating installations may be made over most sub-floors including: Concrete, plywood, OSB, ceramic/porcelain tile, smooth stone, marble, granite, and linoleum. If you are installing over an existing floor, the existing floors must be securely attached (nailed or glued) to the sub-floor and be smooth and flat. When installing over an existing wood or laminate plank floor, the new SPC Herringbone floor must be installed at 90° to the rows in the existing floor.
- Wooden sub-floors: plywood, OSB or boards must be flat. High and low areas exceeding 1/8" per 6' or 3/16" in 10' must be corrected. Sand down high areas, fill low areas.
- Concrete: most concrete sub-floors (slabs) are not flat and must be levelled before installation. In all cases, verify the sub-floor using an 8' long straight edge to locate high and low areas. Low areas should be filled with a self-levelling compound per manufacturer's recommendations. Voids and bumps in the sub-floor may prevent your floor's locking system from locking securely and may damage or weaken the locking system.
- Sweep or vacuum your sub-floor immediately prior to installation ensuring there is no debris or grit on the sub-floor, as it will interfere with proper product installation. Verify your sub-floor is dry and clean.
- Check to ensure your sub-floor is completely smooth. Nail and screw heads must be countersunk. Sand any protrusions including joints/seams between sub-floor sheets. Check your sub-floor structure to ensure there are secure nails or screws every 30cm (12") along the joists and 15cm (6") along bearing supports and seams. This will help to avoid squeaks and warping of the sub-floor. You must replace any de-laminated, swollen, or damaged sub-floor sections.
- NOTE: Avoid installation over sub-floors with excessive flex or deflection. The installation of SPC Herringbone flooring will not reduce any flex or deflections in the sub-floor. Excessive sub-floor deflection may damage the locking system and cause it to fail.

**New sub-floor installation**

- Install the sub-floor perpendicular to floor joists in staggered rows so that joints between adjacent sheets do not line up. 19mm (3/4") plywood is recommended for 16" and 19.2" centre joists. For floors with joists exceeding 19.2" centres, a minimum sub-floor thickness of 32mm (1-1/4") is recommended. Nail or screw the sub-flooring every 150mm (6") along joists to avoid squeaking and warping of the sub-floor.

**Wood sub-floors**

- SPC Herringbone can be installed onto wood sub-floors providing they are smooth, flat, structurally sound and free of defects.
- Acceptable substrates include, particleboard, chipboard, flake board and OSB.
- Please be aware that damage may occur on wood panel sub-floors during construction. The suitability of these floors is the responsibility of the installer.
- If the surface of the wood sub-floor is not smooth, an additional 6.4mm underlay panel should be installed over the sub-floor. Any panels selected as an additional underlay must meet the following criteria:
  - Be dimensionally stable.
  - Have a smooth, fully sanded face so the graining or texturing will not show through.
  - Be resistant to both static and impact indentation.
  - Be free of any surface components that may cause staining such as plastic filler, marking ink, sealer, etc.
  - Be of uniform density, porosity and thickness.
  - Have a written warranty for suitability and performance from the panel manufacturer or have a history of proven performance.

**Concrete sub-floors**

- Most concrete sub-floors (slabs) are not flat and must be levelled before installation
- Concrete sub-floors must be dry, smooth, and free from dust, solvent, paint, wax, grease, oil, asphalt sealing compounds and other extraneous materials. The surface must be hard and dense and free from powder or flaking.
- New concrete slabs must be thoroughly dry (at least six weeks) and completely cured.
- All concrete slabs must be checked for moisture before installation. The final responsibility for determining if the concrete is dry enough for installation of the flooring lies with the floor covering installer. SPC herringbone flooring must never be installed where excessive moisture emissions may exist. In accordance with ASTM F1869 moisture emission from sub-floor cannot exceed 8 lbs MVER (moisture vapour emission rate) per 1,000 sq. ft. per 24 hours as measured with the calcium chloride test or ASTM F 2170 In Situ Relative Humidity Test not to exceed 85%. The supplier will not assume responsibility for floor covering failure due to hydrostatic pressure or excessive moisture vapour emission.
- New concrete slabs must be thoroughly dry (at least six weeks) and completely cured. Although the planks are not susceptible to damage from moisture, excessive sub-floor moisture can be a breeding ground for mould, mildew and fungus. All of which can contribute to an unhealthy indoor environment. The Limited Warranties do not cover issues arising from flooding, leaking plumbing or appliances, water entering through sliding glass doors, presence of mould, discolouration from mould or fungi or similar conditions.
- Holes, grooves, expansion joints and other depressions must be filled with a high quality cement patching & levelling compound, trowelled smooth and feathered even with the surrounding surface.

**Existing floor-coverings**

- SPC herringbone flooring can also be installed over most existing hard-surface floor coverings provided that the existing floor is well bonded and the surface is flat and smooth.
- Ceramic tile unevenness should be made smooth by applying an overlay such as cement patching or levelling compound.
- Existing floors should not be heavily cushioned and not exceed one layer in thickness.
- Do not install over carpet.
- Floor should be flat, smooth, dimensionally sound and free from deflection.



**FIGURE 1**

**NOTE:** The first guideline you set up should be positioned 45mm (1.75") to the right of the centreline as shown below.

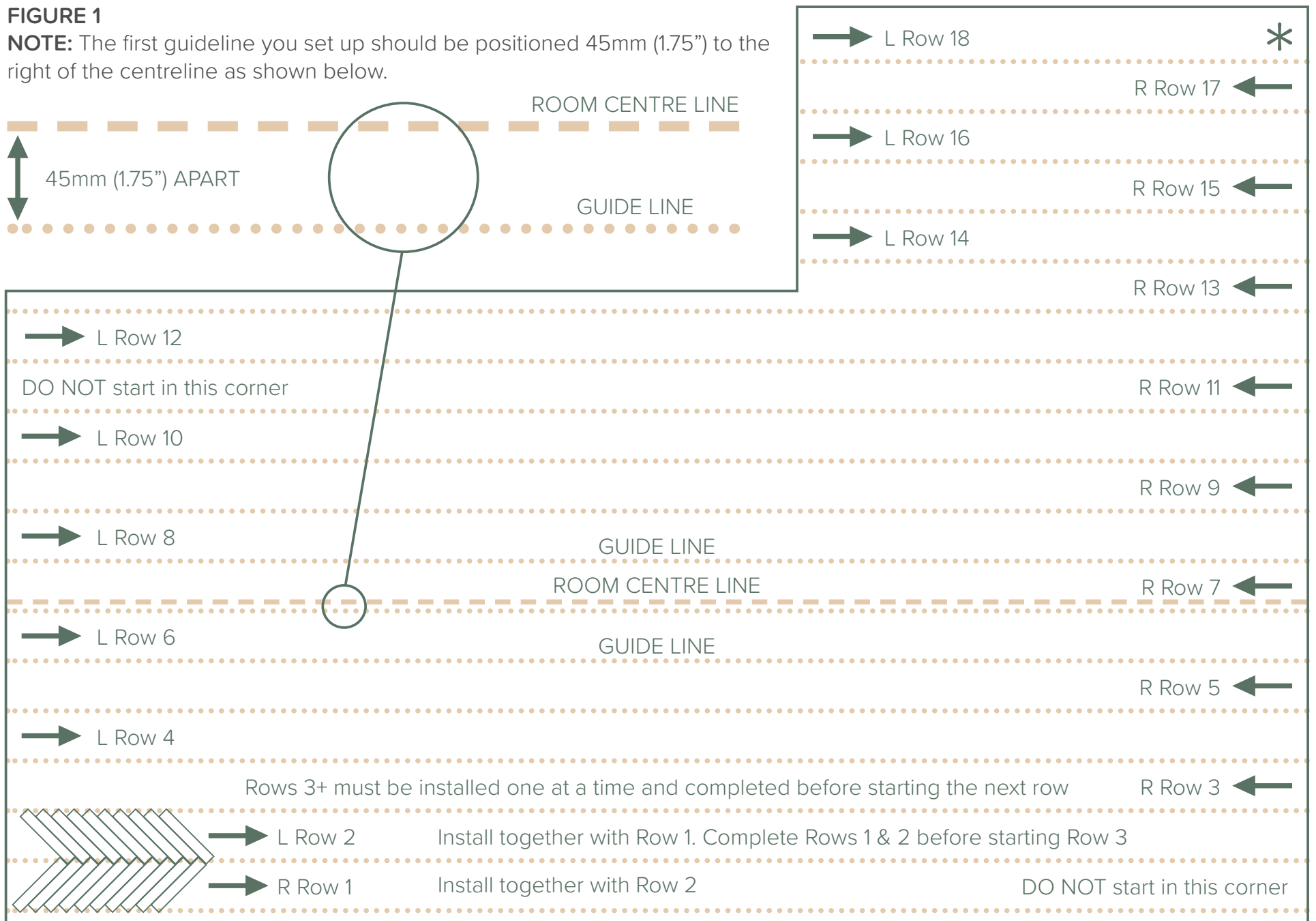

**This product includes an attached thermo-acoustic under-pad: The attached pad provides the following benefits: It will reduce footfall noise transfer to rooms that are below and adjacent to the area where the floor is installed. Additionally, in basement and on-grade concrete slab installations, it will provide a thermal break from the slab and provide you with a warmer floor.**

#### Wall jamb & doorway preparation

Remove all trim, baseboards and quarter rounds. Identify them on their reverse side for re-installation. Remove doorway thresholds, which may or may not require re-installation. For door casings, you will need to notch the bottom of the casing with a saw or chisel so that the SPC Herringbone can slide freely beneath it. To make a straight cut easily, lay a handsaw flat on a piece of scrap flooring as a guide. If the installation is multi-room and rooms are separated by a doorway, each room should be separated by a T-moulding which will be installed as a threshold between the 2 rooms/areas.

#### Basement area installations

SPC Herringbone flooring is not a waterproofing system, any pre-existing moisture water infiltration or flooding problems should be corrected prior to installation. Do not install over concrete slabs with a history of being wet or damp, keeping in mind that a slab that appears dry now, may be wet or damp seasonally. If installation is over new concrete, it must be a minimum of 60 days old and be fully cured.

#### IMPORTANT general tips for installing SPC Herringbone floors

- Installations require the use of transition mouldings between installation areas, doorways, hallways, etc.
- Squeaks are caused when the sub-floor separates from the joist or moves. This happens when there are temperature and humidity changes or when new construction "settles". When the sub-floor moves up and down on a pulled nail or incompletely set screw, it causes the sub-floor to squeak. If you install SPC Herringbone flooring over existing ceramic tiles, skim coat the grout lines with a floor levelling compound and fill or repair any damaged or cracked tiles. Carefully inspect your sub-floor and replace any nails that are not completely secure. Close adherence to installation instructions can minimize the risk of squeaks; however, there is no guarantee or warranty that your floor will not squeak.
- Note: It is recommended that your sub-floor is screwed down rather than nailed down.
- Colour variation in different dye lots should be evenly distributed in your room. To achieve this, draw planks from a minimum of 3 boxes and multiple pallets at a time. Set aside any Planks that have blemishes for use in less visible areas. Plank design variation should also be distributed evenly throughout your room to ensure that planks with a similar design are not adjacent to one another. Install usable cut pieces in closets, adjacent to walls or in other less visible areas.
- Verify locking profile is free of any contamination including: debris, grit, milling chaff or other material; remove any contamination before installing. Also verify that the locking profile was not damaged during shipping or handling. Any pieces with damaged profiles should not be installed in main traffic areas; discard or install in a closet or non-traffic area.
- The preferred method of cutting planks is to use a sharp utility knife; when using this method, you must make a deep score and snap off the end of the plank. Note that you must also cut the attached under-pad as well as the same point where you scored the topside of the plank.
- If you are installing the floor over a crawl space, the crawl space must be a minimum of 18" high and have a plastic vapour barrier

- installed that completely covers the soil; additionally, the crawl space must be adequately ventilated.
- Do not tap directly on the ends or the sides of planks. When using a tapping block, use a regular hammer. If you need to remove a plank, carefully lift up the plank you wish to remove, as well as the previously installed plank and slide it out laterally so not to damage the locking mechanism.
- If any end-seams resist fully closing tight & flush, the use of a rubber mallet will assist in fully locking the ends of planks together. Firmly tap the surface of the plank you are installing along the end-seam to close the seam 100%.
- Do not install lengthwise across distances that exceed 12M (40 feet) or width wise across distances that exceed 12M (40 feet) if the distances exceeds these limitations. If installing in an area that is larger than 12M (40 feet) in either width or length, the floor must be glued down using one of the approved adhesives noted previously.
- It is recommended that adjoining hallways, rooms and other areas are separated by using a T-moulding type transition trim.
- Room and product temperatures must be between 18°C and 29°C when installing SPC Herringbone flooring.

### Getting started

- When installing your SPC herringbone floor, your initial set-up and planning of the room is key to a successful installation. For the optimal appearance of the floor, herringbone floors should be centred along the length of the main body of the room so that the cut pieces on both sides are the same size and the floor symmetrical. Follow the room set-up example shown in Figure 1.
- First measure and mark your installation area's centre line using your chalkline. Next, measure out from the centre line and mark out each of your guide rows using your chalkline, off-setting by 45mm (1.75") from the centre line.
- Each herringbone row is 445mm wide (17.5") wide when measured "corner to corner" of the visible surface of the planks as shown in Figure 3: Use this measurement to plan out and mark where your guide lines will be made using your chalkline. Note that all of your measurements must be very precise, straight and square. Mark all of your guide lines before starting the installation.
- Note that your exterior guide lines along the walls must be 6mm (1/4") from the walls on all sides, as well as along any other vertical surfaces. This space serves as an expansion gap to allow the floor to expand and contract daily/seasonally as indoor temperatures change.
- Note that you can only start your floor installation of either of the 2 opposing corners shown in Figure 2. DO NOT start installing in a different corner or any other position or row in the room. The special locking mechanism of SPC Herringbone planks requires a sequential installation of the planks row-by-row as shown in Figure 1. Refer to Figure 1 for further reference when planning your starting point and row installation sequence. In Figure 1, we have shown a typical living room & dining room area; note how the installation starts in the lower left corner following the longest wall. The alternate starting corner is noted in the opposite corner with a \*, however, this is not recommended since this is the smaller area of the installation. It is always best to follow the longest wall as shown in Figure 1.
- Note that there are two differently milled herringbone planks in each box, 12 RIGHT and 12 LEFT; you can easily identify them with their different profiles as shown in Figure 3. When opening boxes, set out planks in separate piles of LEFT and RIGHT planks to make installation more convenient. Each row will use only LEFT or RIGHT planks as shown in Figure 1. You cannot mix them per row.

FIGURE 2

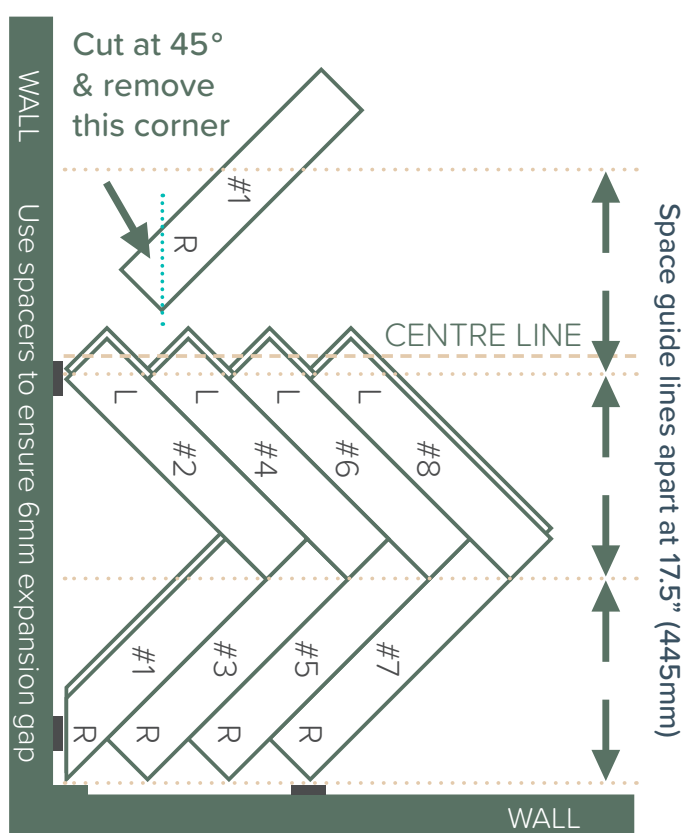

### Starting the first row

- Starting your first row started is simple; position and lock right and left planks together in the sequence shown in Figure 2. This will form a double row (row #1 will use RIGHT planks only and row #2 will use LEFT planks only) in the form of an "inverted V". Position and lock each plank in place exactly following the numbered sequence shown.
- Use the next plank to help to precisely align the previous plank; this will make installation faster and more accurate. For example: plank #3 will help you to exactly align plank #2, plank #4 will help you to exactly align plank #3 and so on. Refer to Figure 4 for visual reference.

FIGURE 3

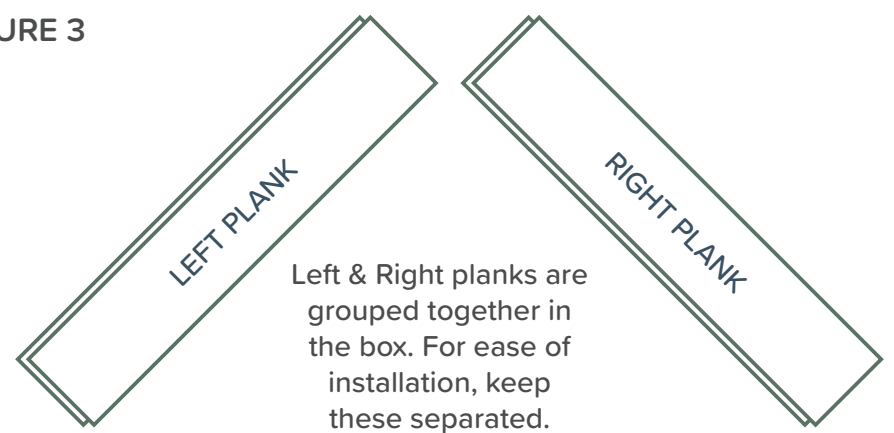
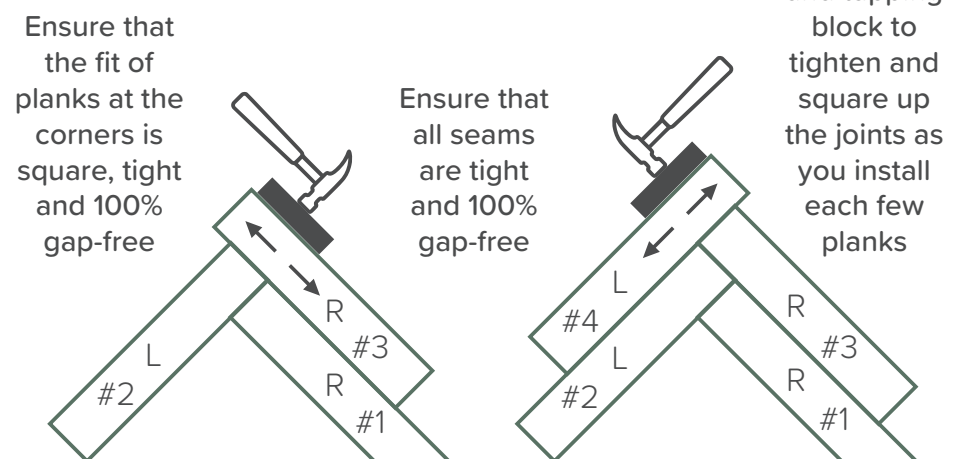

FIGURE 4



- It is very important to ensure that when you lock planks together that they are perfectly tight and square to each other. There cannot be any small gaps whatsoever; use your tapping block as shown in Figure 4 to tighten up any gaps and keep planks square at 90°.
- Once you have the first 8 planks locked together, shift and position the block of 8 planks to exactly follow and be aligned with your starting row guide lines. Be certain to leave the 6mm (1/4") expansion gap as shown in Figure 2.
- Place 6mm (1/4") spacers or shims every approx. 8 planks to help keep your floor from shifting as you install it as shown in Figure 2. Planks must never be in direct contact with any wall, cabinet or other vertical surface.
- Continue to install your starting row; after each 8 planks, stop and check that all of your planks are 100% tightly locked together and that there are no gaps. Also check that both rows are following your chalk lines exactly and not deviating from them whatsoever. If needed, gently shift your rows of planks so that you are exactly following your 2 chalk lines.
- **You must fully install your starting double starting rows #1 & #2 100%, do not commence to install any other rows or parts of the floor until your starting double row is 100% completed, perfectly straight and free of any gaps.**
- You are now ready to start row #3 which will only use RIGHT format planks.
- With the exception of rows #1 & #2, all even # rows will start on one side of the room and all odd # rows will start on the opposite side of the room as shown in Figure 1.
- When installing each plank in rows # 3 onward, use your tapping block & hammer to tighten up each plank as you go; a firm tap will ensure all small and hard to see gaps are eliminated and that each plank is perfectly square at 90° to the previous row. Never tap a plank directly with a hammer or other object, you risk damaging the locking profiles, always use your tapping block.
- As mentioned earlier, after each 8 planks in all rows, stop and check that all of your planks are 100% tightly locked together and that there are no gaps.
- After row #3 is 100% complete, start row #4 and install it 100% following all steps previously mentioned. Continue installing all remaining rows completely one-at-a-time until all rows are 100% finished except for cut rows.
- Note that you may use a rubber mallet to tap on the surface of planks to help set them into place.

### Cuts and details

- Now that you have all of the main body of the floor installed, you are ready to start to install your cut rows and fill in your "triangle" shaped openings at each end of the room.
- Installing your cut plank sections requires the use of a vinyl seam sealer to secure them in place; it is quick and easy to use. Follow the seam sealer manufacturer's recommendations and precautions; always immediately wipe away any excess seam sealer and clean the area with a clean damp paper towel. Use only one of the following approved vinyl seam sealers:
- Using a suitable Vinyl Floor Seam Sealer.

The procedure to fill in each of the remaining cut areas of the floor is different; follow as noted below for each area:

#### A. Cut row alongside ROW #1 where installation started:

- You will only use "LEFT" planks for this entire cut row, refer to Figure 6.
- Mark your cut-line on the plank at 45° so that when installed, you maintain the required 6mm (1/4") expansion gap, refer to Figure 5.
- Measure carefully and cut the plank to the required size.
- Using your utility knife, carefully trim off the outer lip of the female profile from ONLY the end of the cut plank so that it can be easily inserted into the floor; refer to in Figure 6.
- Apply a bead of vinyl seam sealer to both of the female profiles as shown in Figure 6.
- Insert the cut plank into the floor so that it fits tightly.
- Immediately and thoroughly wipe up any excess seam sealer that may bleed through from the seams using a clean paper towel.
- If necessary, secure the cut sections with a small piece of blue or green painter's tape until the seam sealer sets and dries.

FIGURE 5

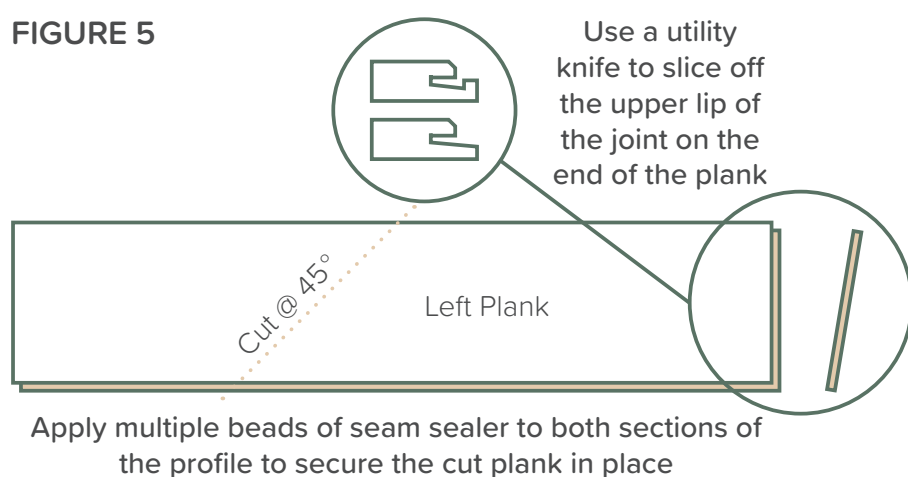

#### B. Cut row alongside the LAST ROW where installation finished:

- Depending on the direction of your last row, you will use only either "LEFT or RIGHT" planks for this entire cut row, refer to Figure 6. For example: if your last full row used LEFT planks, your cut row will RIGHT planks.
- Regardless of the direction of your last row, the planks when cut to 45°, will quickly and easily drop into place using the same method as installing a regular row of planks.
- Mark your cut-line on the plank at 45° so that when installed, you maintain the required 6mm (1/4") expansion gap.
- Before inserting the cut planks, apply multiple beads of vinyl seam sealer to both of the female profiles of the existing planks in the floor where the cut plank will fit.
- Immediately and thoroughly wipe up any excess seam sealer that may bleed through from the seams using a clean paper towel.
- If necessary, secure the cut sections with a small piece of blue or green painter's tape until the seam sealer sets and dries.



### C. Triangle openings at both ends of the room:

- Filling in the open triangle areas will use both “LEFT or RIGHT” planks, refer to Figure 6 to see the order of installing each area.
- As you install each plank, you will alternate between the methods A & B above since installed planks will alternate between “LEFT or RIGHT” planks.
- To minimize waste, depending on the length of cut plank needed, use previously cut planks where possible.
- Mark your cut-line on the plank at 45° so that when installed, you maintain the required 6mm (1/4”) expansion gap.
- Before inserting the cut planks, apply multiple beads of vinyl seam sealer to both of the female profiles of the existing planks in the floor where the cut plank will fit.
- Immediately and thoroughly wipe up any excess seam sealer that may bleed through from the seams using a clean paper towel.
- If necessary, secure the cut sections with a small piece of blue or green painter’s tape until the seam sealer sets and dries.

### Maintenance of your SPC herringbone flooring

- Regular vacuuming and periodic cleaning of your SPC herringbone flooring floor will protect its beauty and lasting finish. More frequent attention is recommended in high traffic areas, as well as near exterior and garage entrances. For a thorough clean, use specially formulated vinyl or hardwood flooring cleaning products and a micro-fibre mop available at most hardware and flooring retailers. Use as per the manufacturer’s recommendations. You may also damp mop your SPC herringbone flooring floor using warm water with a small amount of mild liquid soap.
- Do not use cleaning products which contain surfactants or which leave a residue. Use of these products will leave a dull film on the surface of your floor and will void the product warranty. Before using any cleaning product, test it first on a small, less visible area of the floor.
- Place small non-slip mats or rugs at all exterior or garage entrances to the home to protect the floor from dirty shoes, boots etc. This will remove loose dirt and debris from shoes. Clean rugs and mats on a regular basis.
- Do not use polishing products. The use of these products may leave a dull residue and will void your warranty.
- Do not use abrasive products, bathroom cleaning products, ammonia based products, wax based polishes/cleaners, acrylic finishes, acidic or vinegar based solutions, oil soaps, detergents, chlorine based products, bleach, solvents or any type of polishes. The use of these products may permanently damage the finish of your floor and will void the warranty.
- Keep your pet’s nails trimmed, as their nails may scratch the floor. Note that pet nails from medium to larger sized pets may leave minor marks on the surface of this floor due to the floor’s finish abrading the pet’s nails; this is normal and is not considered as damage to the floor.
- Clean spills immediately to prevent them from running between the cracks. Small spills should be cleaned up with a lightly dampened cloth and a small amount of mild liquid soap.
- Do not roll or slide furniture or appliances with castors across the floor. Castors may damage the floor’s finish. Carefully and safely lift and move the object into place. To minimize possible wear and damage, felted furniture leg coasters are recommended under furniture legs. Install felt floor protectors under furniture legs to avoid scuffing or scratching. Clean or replace felt protectors on a regular basis to remove built up grit that may have become embedded. Chairs with castors must be fitted with only barrel (roller) type castors and have a protective mat or carpet placed under the chair in the area where the chair moves.
- High heels with missing heel lifts can cause denting to SPC herringbone flooring. Damage resulting from any footwear is specifically excluded from this warranty.
- Minor damage or gaps can be repaired using vinyl seam sealer available from your local hardware or flooring supplier. Follow manufacturer’s instructions. Save all leftover planks to use as replacements in the event of damage.

### Important facts

- Do not install SPC herringbone flooring over any type of soft underlay like foam, carpet or other soft, rough, uneven or non-flat surfaces.
- Protect from direct sunlight. Direct exposure to sunlight from large windows and patio doors can cause the surface of the floor to exceed the product installation temperature limitations; in south to west exposure rooms with multiple and/or large windows or patio doors, it may be necessary to install blinds or drapes. Rapid temperature change (heat from direct sunlight) may cause floor to temporarily expand in these areas.
- SPC herringbone flooring is designed for indoor use only and is not approved for any type of exterior use; installation outdoors will void product warranty.
- SPC flooring is not suitable for rolling loads (manual or electric) from a wheelchair to other rolling loads.

FIGURE 6 : Completing cut sections of the floor

